

# STEEL BUILDINGS

PRECISION-ENGINEERED



**Prefer a digital version?**

Scan the QR code with the camera on your smartphone to view this brochure





# DESIGNED FOR YOU.

## SUKUP STEEL BUILDINGS

The clear span design of a Sukup Steel Building allows you to customize your building to fit your specific requirements. Whether you need an agricultural building to house livestock, materials, or large machinery, or you are looking for an industrial or commercial structure, you can have it with a Sukup Steel Building.

Sukup's sturdy, rigid frame structure allows for ample amounts of open area. This is perfect if you need room to fold out your planter and check the row units or if you need space for storage or machinery. Sukup structures are also easily customizable. Want to add an office or separate work bays? With a Sukup Steel Building you can get everything you are looking for in a shop or machine shed.



### WHY BUY A SUKUP STEEL BUILDING?

- Clear span up to 200' for large open areas
- Multi-span construction available to reduce cost
- Purlins, girts and eave struts are pre-punched to ensure a proper fit and faster installation
- Factory welded clips mean fewer pieces and bolts, lowering construction costs
- Purlins, girts and eave struts are galvanized for long life
- Choose from twelve exterior and trim colors
- Sukup Steel Buildings are IAS AC472 accredited



# FRAMING

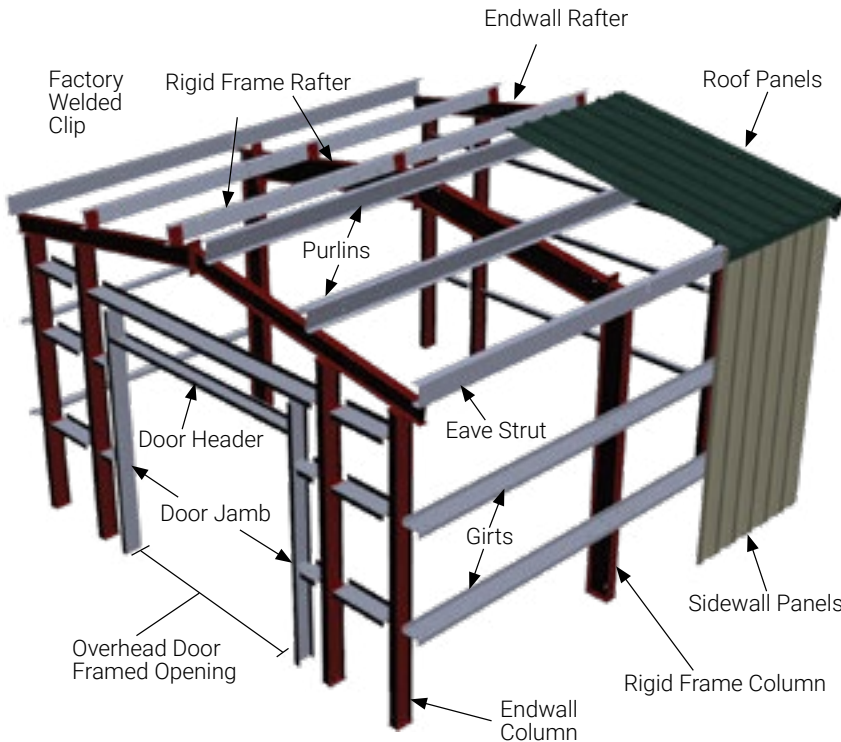

\*Example: Framing will vary based on design.

## WHY BUILD WITH STEEL?

- **STRENGTH** - Steel buildings generally withstand higher winds and loads than wood.
- **DURABILITY** - Steel buildings outlast wood buildings and are completely recyclable. Decommissioning a wood building only pays you back with a bonfire (after removing the panels).
- **CLEAR SPAN** - Steel building can clear span greater distances than wood.
- **INSIDE CLEARANCE** - Steel buildings provide greater inside clearance than wood because of the rigid frame rafter design. The common bay size of a steel building is greater than a wood building as well.
- **ELEMENTAL RESISTANCE** - Steel buildings are safe from termites, rot and mold, and drying out. Steel buildings won't shrink, warp, or swell.

## The Colors You WANT. The Quality You DESERVE.

All Sukup standard colors are coated with CERAM-A-STAR® 1050. This is an industry leading coating system that utilizes superior reflective qualities to effectively and efficiently cool your steel building. It is so effective it even qualifies for an energy credit under the federal tax code. Additionally, CERAM-A-STAR® 1050 offers exceptional abrasion resistance and color life. It features a 40-year adhesion warranty and 30-year fade warranty.

Polar White

Rustic Red

Hawaiian Blue

Light Stone

Gallery Blue

Ash Gray

Burnished Slate

Saddle Tan

Bright Red

Charcoal Gray

Fern Green

Stealth Black

*\*Color reproduction may vary. This color chart is for reference only and is not to be used for final color choice. See actual color sample from supplier to determine true color.*

*Sukup Manufacturing Co. provides the information to assist you in choosing the optimal equipment for your situation. Sukup specifications should only be used as estimates, and not as a warranty, expressed or implied, of how a particular Sukup unit will perform under your operating conditions. Because we are continually improving Sukup products, changes may occur that may not be reflected in the specifications.*

# DESIGNED TO LAST.

# ROOF PANELS

## Standing Seam Roof (CXP)

The point of putting up a building to house your machinery, shop and/or office is to keep your property dry and safe. Doesn't it make sense then, to put up a building that's virtually leak-proof? The seams on Sukup standing seam roofs are mechanically rolled in the field to create a 360° Pittsburgh double lock seam. This seam creates a tight, durable, virtually leak-proof seal.

- 24 gauge
- 24" coverage
- 3" rib height
- Concealed fasteners and clips
- 50 grade
- Offered in Galvalume®+ and Polar White (other colors can be special ordered)

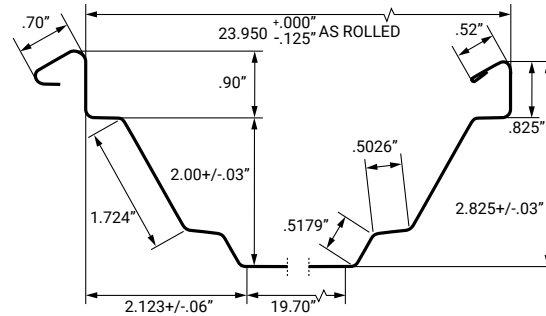

## Screw-Down Roof (MAP)

Sukup also manufactures a screw-down roof. This style of roof is economical and simple to install. Screw-down roofs are available in Galvalume®+ and all Sukup standard colors.

- 26 gauge
- 36" coverage
- 1 1/2" rib height
- 12" on center
- 50 grade
- Offered in Galvalume®+ and all Sukup standard colors

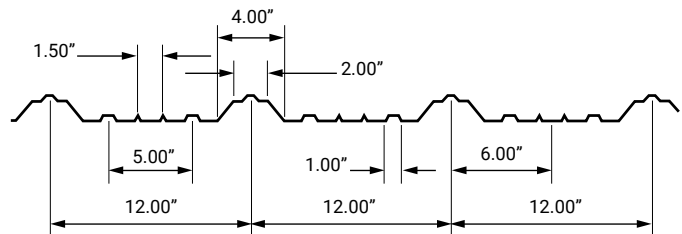

## Standing Seam Roof (SA16)

- 24 gauge
- 16" coverage
- 2" tall major rib height
- Compatible with curved roof design. 125' maximum radius. 300' minimum radius
- Offered in Galvalume®+ and all Sukup standard colors

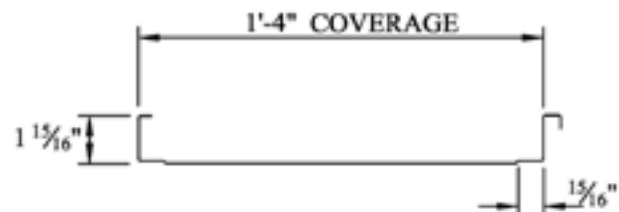

# WALL PANELS

## Exterior Wall Panels (MSP)

Sukup exterior wall panels are made from 26 gauge steel and feature extra deep 1 1/4" ribs for greater durability and strength. Exterior panels are available in all 12 Sukup standard colors and Galvalume®+ so your building can have both strength and beauty.

- 26 gauge
- 36" coverage
- 1 1/4" rib height
- 12" on center
- 50 grade
- Offered in Galvalume®+ and all Sukup standard colors

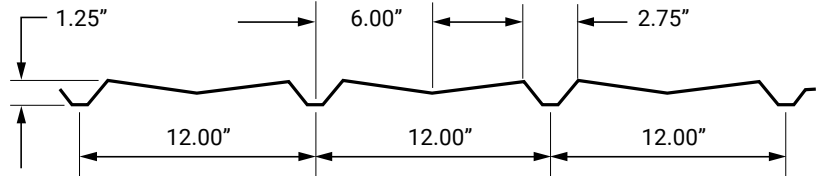

## Liner Panels (MIP)

Sukup also offers an interior liner panel to give a nice finished look to the inside of any building

- 29 gauge
- 36" coverage
- 3/4" rib height
- 6" on center
- 50 grade
- Galvalume®+ (pre-painted polar white only)

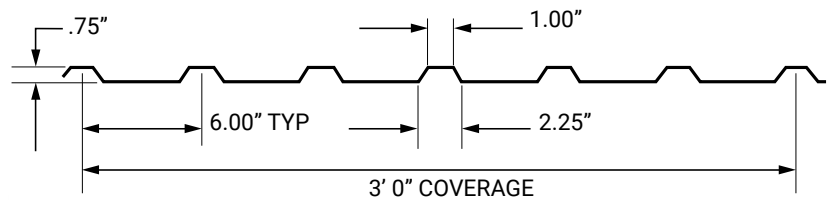

Sukup wall and roof panels are made from Galvalume®+ AZ-55 substrate for superior corrosion resistance, so they will look good for years to come.



# GET YOUR BUILDING. THE WAY YOU WANT IT.

Sukup Steel Buildings feature a number of options including a full line of walk-in doors, windows, fiberglass insulation packages, translucent wall panels, canopies and more! You can be sure you will get exactly what you want.

## Walk-In Doors



## Windows



## Wainscoting



## Gutters & Downspouts



## Eave & Rake Extensions



## Fiberglass Insulation

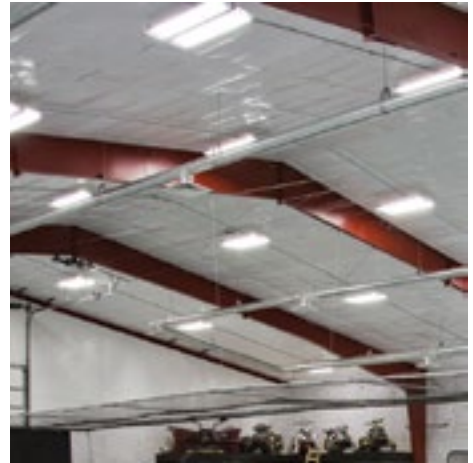

*Skyliner® or Standard*

Our main manufacturing facilities and offices in America's heartland - Sheffield, IA - along with our six distribution centers, cover more than one million square feet of manufacturing space. In 2014 we completed construction of our new corporate office building. We manufactured more than 700,000 pounds of structural steel in-house to complete this project.



# SUKUP HEADQUARTERS



Sydenstricker Implement, Chillicothe, MO



The Copper Penny, Pilot Grove, MO



Croell Inc., Charles City, IA



7 Oaks Farm, Kingsburg, CA



Beckman & Gast Co, St. Henry, OH



Kludt Brothers, Inc., Kendall, NY



Dungey's Furniture, New Hampton, IA



Hamilton Distributing Warehouse, Hamilton, MI

Sukup Manufacturing Co. is the world's largest family-owned and operated manufacturer of grain storage, drying, and handling equipment. The company is headquartered in America's heartland – Sheffield, Iowa – and covers over one million square feet of office, manufacturing, and warehouse space.

Sukup® constantly strives to push the boundaries of innovation and quality and currently holds the record for the world's largest grain bin that holds 2.2 million bushels of corn. The company prides itself on their philanthropic efforts in giving back to local, statewide, and international charities including the design and construction of Safe T Home®, a patented structure suitable for recovery efforts.



## Take a look at our Sukup Products



### Triple Run Conveyor

- Multi-functional conveyor for receiving or reclaiming grain.
- Utilizes a low profile design capable of being flood fed.
- Self-cleaning conveying sections (patent pending.)
- Reclaim style will fit under 17" floor and has a Powersweep option.
- Grain conveys in upper chamber on 3/16" AR divider pan.



### Bucket Elevator

- Low impact head design for better grain quality.
- Squaring Plates for Efficient Assembly & Increased Strength.
- Welded frames on head & boot sections.
- UHMW seals on all shafts.
- Large head service platform.



**Sukup Manufacturing Co. | [www.sukup.com](http://www.sukup.com)**

Box 677 1555 255th St. | Sheffield, IA 50475-0677 | ph 641.892.4222  
fx 641.892.4629 | [info@sukup.com](mailto:info@sukup.com)

### Distribution Centers

Arcola, IL 61910  
980 E. State Rte. 133  
ph 217.268.3026  
[illinois@sukup.com](mailto:illinois@sukup.com)

York, NE 68467  
2311 N Division Ave  
ph 402.534.1108  
[nebraska@sukup.com](mailto:nebraska@sukup.com)

Cameron, MO 64429  
7426 NE 352nd St.  
ph 816.649.2226  
[missouri@sukup.com](mailto:missouri@sukup.com)

Defiance, OH 43512  
7724 Rte. 66 N.  
ph 419.784.9871  
[ohio@sukup.com](mailto:ohio@sukup.com)

Jonesboro, AR 72403  
204 Best Industrial Dr.  
ph 870.932.7547  
[arkansas@sukup.com](mailto:arkansas@sukup.com)